

Scheibengröße und
 Scheibenform variabel
 F = Friesbreite mind. 130 mm



 System Schröders
 Türen und Tore

T90-2-Tür / Tor
 "System Schröders TSN-12"
 Ansicht mit Schnitten

Einbauvarianten

Einbau in

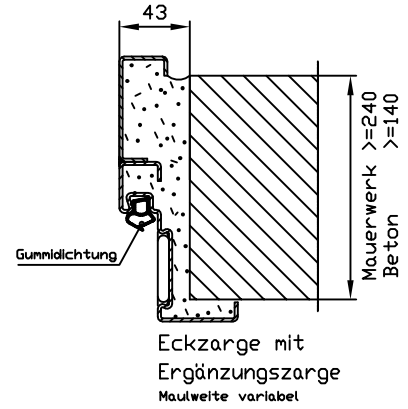
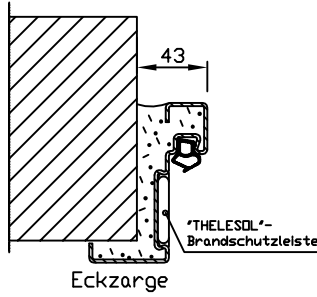
Mauerwerk/
Beton



Mauerwerk/
Beton

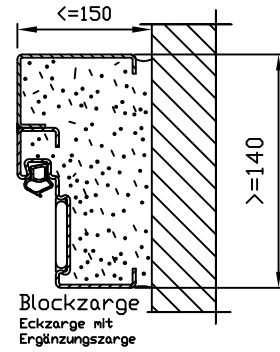

Montagewand
F90

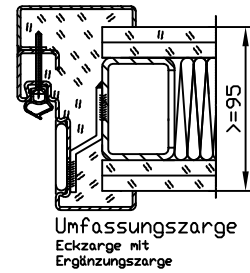
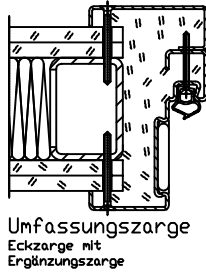

Gasbeton

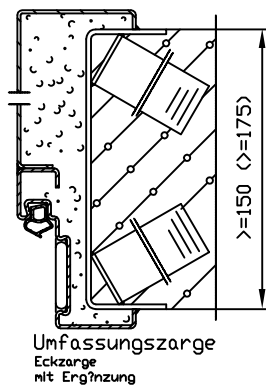
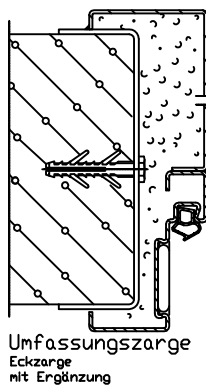

System Schröders
Türen und Tore

T90-2-Tür /Tor
"System Schröders TSN-12"
Einbauvarianten