

## Tür

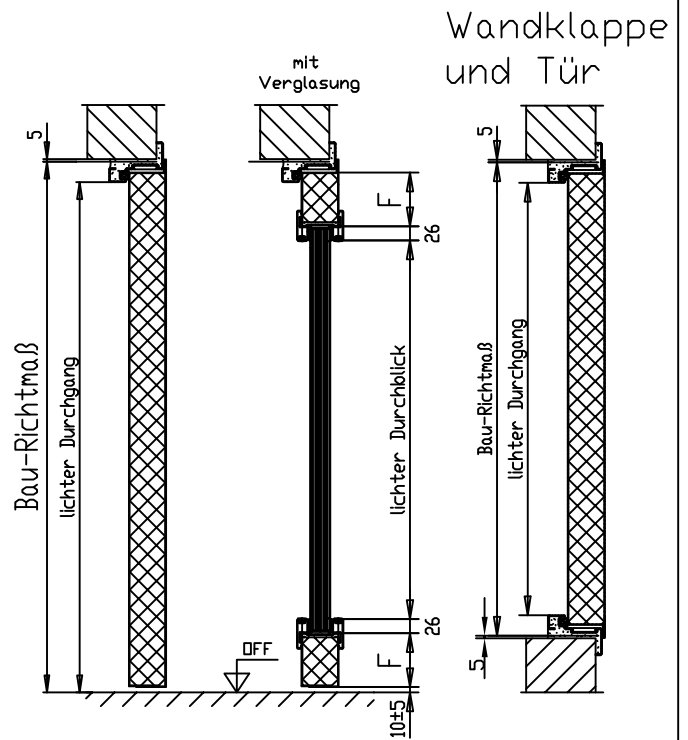

## Wandklappe

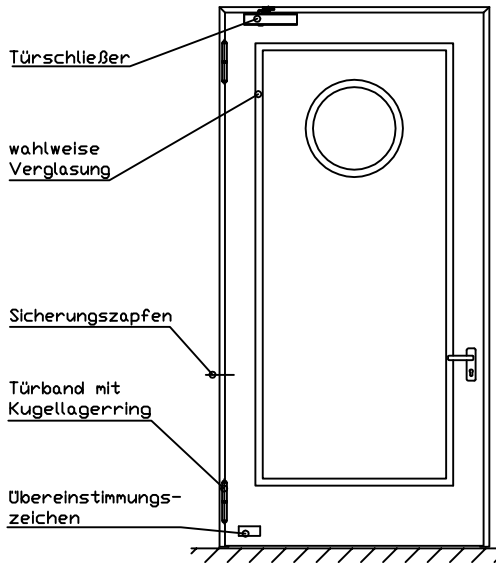
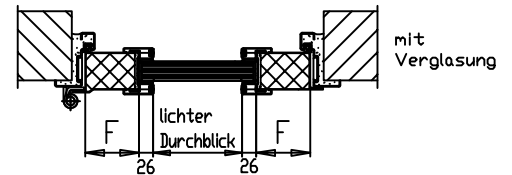
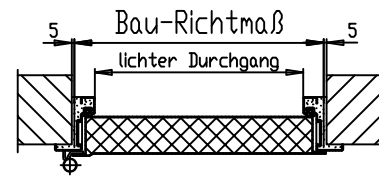
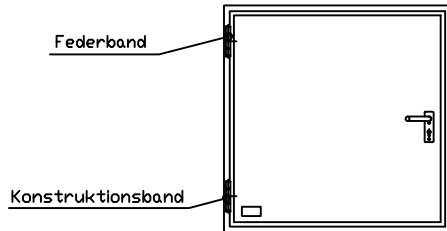

Scheibengröße und  
Scheibenform variabel  
F = Friesbreite mind. 130 mm



System Schröders  
Türen und Tore

T90-1-Tür / Wandklappe  
"System Schröders TSN-11"

Ansicht mit Schnitten

# Einbauvarianten

Einbau in

Mauerwerk/  
Beton

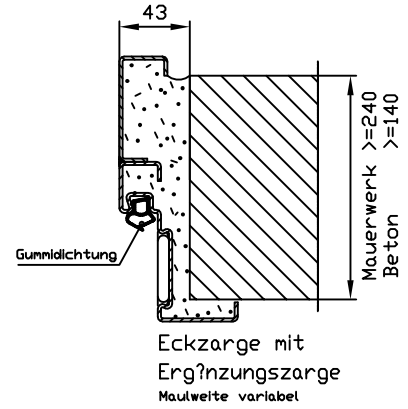
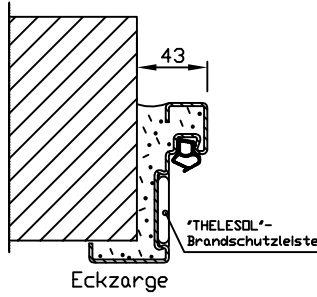

Mauerwerk/  
Beton

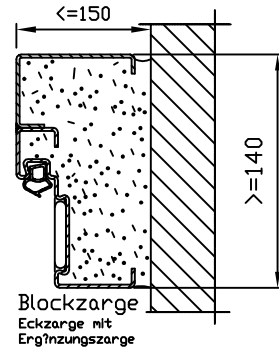

Montagewand  
F90

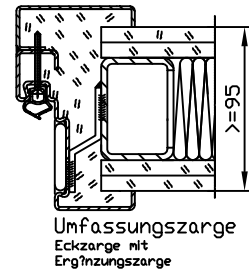
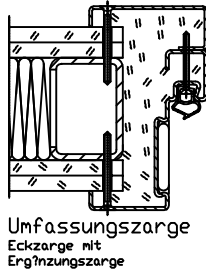

Gasbeton

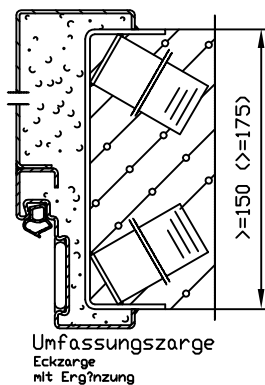
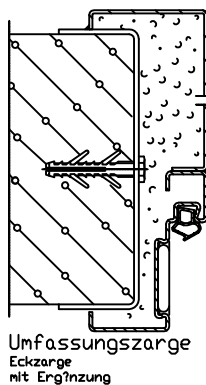

System Schröders  
Türen und Tore

T90-1-Tür / Wandklappe  
"System Schröders TSN-11"  
Einbauvarianten